



# UNI

## MP100 Series Quick Start Guide



### mPower Electronics Inc.

3046 Scott Blvd. Santa Clara, CA 95054  
www.mpowerinc.com  
info@mpowerinc.com

PN: M001-4029-000

v1.41

## Warning

- Never operate the monitor when the cover is removed.
- Remove the monitor cover and battery only in area known as non-hazardous.
- Use only mPower's lithium battery part number M500-0001-000 [1.17.02.0002] (3.6 V, 2700 mAh, AA size).
- This instrument has not been tested in an explosive gas/air atmosphere having oxygen concentration greater than 21%.
- Substitution of components will impair suitability for intrinsic safety and void warranty.
- It is recommended to bump test with a known concentration gas to confirm the instrument is functioning properly before use.
- Before use, ensure that the colorless ESD layer on the display is not damaged or peeling. (The blue protective film may be removed.)

## Avertissement

- N'utilisez jamais le moniteur lorsque le couvercle est enlevé.
- Retirer le couvercle du moniteur et la batterie uniquement dans une zone connue comme non dangereuse.
- Utilisez uniquement le numéro de pièce de la batterie au lithium mPower M500-0001-000 [1.17.02.0002].
- Cet instrument n'a pas été testé dans une atmosphère explosive gaz / air ayant une concentration en oxygène supérieure à 21%.
- La substitution de composants compromettra l'aptitude à la sécurité intrinsèque et annulera la garantie.
- Il est recommandé de tester avec un gaz de concentration connue pour confirmer que l'instrument fonctionne correctement avant de l'utiliser.
- Avant l'utilisation, assurez-vous que la couche ESD incolore de l'écran n'est pas endommagée ou épluchée. (Le film protecteur bleu peut être enlevé.)

## Read Before Operating

The User's Guide must be carefully read by all individuals who have or will have the responsibility of using, maintaining, or servicing this product. The product will perform as designed only if it is used, maintained, and serviced in accordance with the manufacturer's instructions.

## User Interface

The UNI's user interface consists of the LCD display, LEDs, an alarm buzzer, two keys: Left Key [Confirm/Number increasing] and Right Key [Power/Cursor moving], an alligator clip, and a chemical sensor.

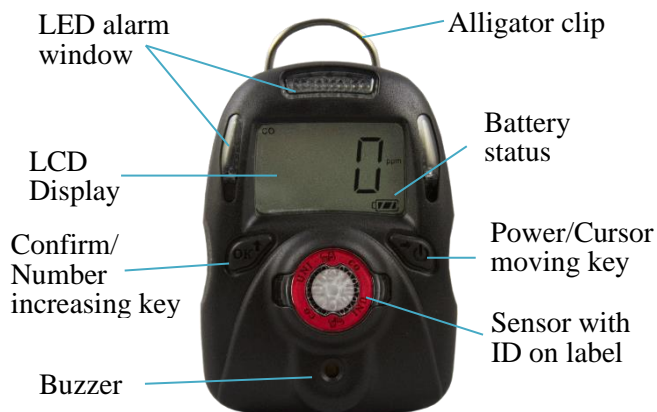

3

## Display Detail

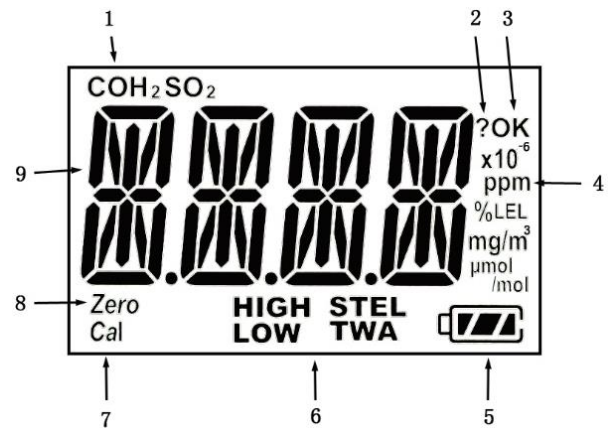

1. Gas name, including CO, H<sub>2</sub>S, SO<sub>2</sub>, or O<sub>2</sub>
2. Question mark (perform operation?)
3. OK status indicator (or accept number entry)
4. Concentration unit, e.g. ppm, %, mg/m<sup>3</sup>, etc.
5. Battery charge status
6. Alarm type indicator
7. Zero in progress indicator
8. Calibration in progress indicator
9. Concentration or other numerical value

4

### Turning the Unit On

Press and hold the Right Key for 4 seconds, until the LCD displays "On", the buzzer beeps, and the green LED is on. The unit enters a warm up and self-test sequence, shows the firmware version, e.g. "VER", "1.0.0.0" and the programmed alarm limits, STEL, TWA, etc.

**Note:** Some units may need several minutes to an hour to stabilize and should be re-zeroed at that time.

### Turning the Unit Off

In normal display mode, press and hold the Right Key for a 5-sec. count down until the unit powers off.

### Normal mode

In normal mode, the gas concentration displayed on the LCD continuously and the unit alarms if a pre-set limit is exceeded. The user can check various other values like STEL, TWA, PEAK, and (for O<sub>2</sub>) MIN by pressing the Right Key. Alarm events are also shown.

### Enter Configuration Mode

Press and hold the Left and Right keys together for 3 seconds, until "PWD" is displayed, prompting password entry. To input the password, use the Left Key to increase the number, and the Right Key to move the cursor. After all four digits are entered, the cursor will move to "OK". Use the Left Key to accept and enter Config Mode.

5

### Configuration Mode Menu

In Config Mode the user can do calibrations and change various operating parameters:

- AiR, SPAN: Zero or Span calibration,
- BUMP: Bump test
- SET HIGH\LOW\STEL\TWA alarm limits
- SET Cal: Change span value
- CAL INTV, BUMP INTV span or bump interval
- SET UniT: Change concentration unit
- Vib SET: Vibrator enable/disable
- P-on Zero SET: Power on zero enable/disable
- FAST SET: Fast power on enable/disable
- RST cF9: Reset configuration to default values
- EXIT: Exit Config Mode

In Config Mode, in general, use the Left Key to increase a number or confirm, and use the Right Key to move the cursor or move to the next programming item.

### Exit Configuration Mode

Scroll to "EXIT?" and press the Left Key to exit Config Mode and return to Normal Mode.

### Daily Self-Test

Press the Left Key to confirm that the LEDs flash, the buzzer beeps and the unit vibrates if programmed to do so.

6

### Alarm Limits

To adjust an alarm limit, enter Config Mode and scroll to the desired alarm: SET HIGH\LOW\STEL\TWA?.

- Press Left to display the alarm value with the first digit flashing
- Use Left to move to the desired flashing digit
- Use Right to increase the value and cycle 0-9.
- When finished, scroll Right to OK and press Left to save and exit.

### Zero (Fresh Air) Calibration

**Buzzer**  
Zero calibration sets the base line for the sensor and is done in fresh air or other clean air source. Enter Config Mode and "AiR?" displays as the first menu item. Press the Left key to start the 15-second zero calibration count-down, after which a "pass" or "fail" result will be displayed.

To abort, press the Right key at any time during the 15-second count, and "AbRT" displays to confirm.

7

### Span Calibration (continued)

Span calibration uses a known concentration gas to determine the response of the sensor to the gas.

1. Attach the Calibration Adapter over the inlet port on the front of unit by pressing it into place.

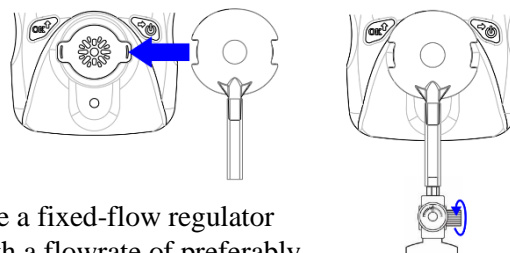

Use a fixed-flow regulator with a flowrate of preferably about 0.3 to 0.5 LPM. Higher flowrates can be used if necessary, but not lower. For reactive gases, e.g., hydrogen chloride, hydrogen fluoride, ozone, chlorine dioxide, phosphine, ammonia and ethylene oxide, be sure to use Teflon tubing connections.

2. Enter Config Mode and scroll to "SPAN?"
3. Start the gas flow, and press the Left key to start the calibration countdown. The default count time is 60 seconds, but some sensors will go longer.
4. When finished, a "pass" or "fail" result will be displayed. Turn off the gas supply, remove the calibration adapter, and exit to Normal Mode.
5. To abort at any time during the count-down, press the Right Key and "AbRT" is displayed.

8

## Maintenance and Service

If used in high-dust environments, replace the inlet filter regularly. Battery and sensor can be replaced as needed. For other maintenance, contact mPower's service department or refer to the full User Manual.

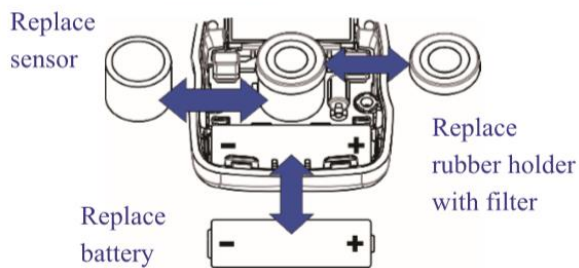
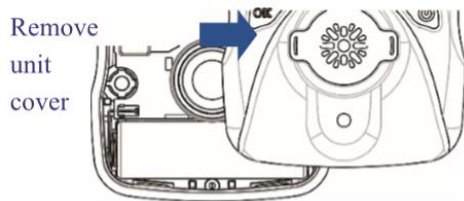
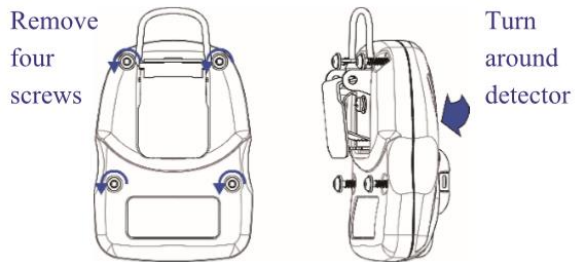

9

## Proper Product Disposal at The End Of Life

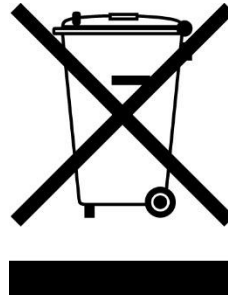

The Waste Electrical and Electronic Equipment (WEEE) directive (2002/96/EC) is intended to promote recycling of electrical and electronic equipment and their components at the end of life.

This symbol (crossed-out wheeled bin) indicates separate collection of waste electrical and electronic equipment in the EU countries. This product may contain one or more nickel-metal hydride (NiMH), lithium-ion, or alkaline batteries. Specific battery information is given in this user guide. Batteries must be recycled or disposed of properly. At the end of its life, this product must undergo separate collection and recycling from general or household waste. Please use the return and collection system available in your country for the disposal of this product.

10